

**CITY OF TIFFIN ORDINANCE NO. 2026-525**

AN ORDINANCE AMENDING THE OFFICIAL ZONING MAP OF THE CITY OF TIFFIN, IOWA, TO REZONE ANDERSEN ADDITION - PART THREE, FROM R-12/OPD CONCEPT DISTRICT TO R-1D/OPD SITE AND CONCEPT DISTRICT FOR LOTUS HILL NORTH, IN THE CITY OF TIFFIN, IOWA, JOHNSON COUNTY, IOWA, AND AS LEGALLY DESCRIBED HEREIN

BE IT ENACTED BY THE CITY COUNCIL OF TIFFIN, IOWA:

Section 1. Purpose. The purpose of this ordinance is to amend the official zoning map of the City of Tiffin, Iowa, concerning Andersen Addition Part Three – Lotus Hill North, Tiffin, Johnson County, Iowa, attached hereto and incorporated herein.

Section 2. Amendment. The following legally described property:

DESCRIPTION - PROPOSED OPD-LOTUS HILL NORTH ZONING

COMMENCING at the Northeast Corner of said Southwest Quarter of the Northwest Quarter of Section 22, Township 80 North, Range 7 West, of the Fifth Principal Meridian, Tiffin, Johnson County, Iowa; Thence S00°50'43"E, along the East Line of said Southwest Quarter of the Northwest Quarter, 644.93 feet, TO THE POINT OF BEGINNING; Thence continuing S00°50'43"E, along said East Line, 158.00 feet; Thence S89°29'44"W, 1066.64 feet; Thence Northwesterly, 90.89 feet, along a 300.00 foot radius curve, concave Northeasterly, whose 90.54 foot chord bears N81°49'32"W; Thence N73°08'48"W, 139.96 feet; Thence Northwesterly, 61.48 feet, along a 300.00 foot radius curve, concave Northeasterly, whose 61.37 foot chord bears N67°16'34"W; Thence N61°24'20"W, 12.10 feet. to a Point on the East Line of Andersen Addition - Part Two, in accordance with the Plat thereof Recorded in Plat Book 66 at Page 62 of the Records of the Johnson County Recorder's Office; Thence Northeasterly, 75.78 feet. along said East Line, on a 960.00 foot radius curve, concave Southeasterly, whose 75.76 foot chord bears N30°51'22"E; Thence N33°07'03"E, along said East Line, and the Northeasterly Projection thereof, 134.23 feet; Thence S56°52'57"E, 109.95 feet; Thence S70°13'15"E, 124.30 feet; Thence N89°29'44"E, 1033.18 feet, to the POINT OF BEGINNING. Said OPD-Lotus Hill North Zoning Parcel contains 4.96 Acres, and is subject to easements and restrictions of record.

shall be changed from zoning classification R-12/OPD (Multi-Family, 9 thru 12 plex OPD) to R-1D/OPD (Single-Family/OPD) Site and Concept District in Tiffin, Iowa, and that the official zoning map of the City be amended to reflect the change described herein. Approval of this zoning classification change is subject to Council approval of a Developer's Agreement as required by the City, Planned Development Overlay District

Agreement(s) as required by the City and compliance with the requirements of the Tiffin Zoning Code - Planned Development Overlay District, and the Developer executing all easement agreements the City may require.

Section 3. Repealer. All ordinances or parts of ordinances in conflict with the provisions of this Ordinance are hereby repealed.

Section 4. Severability. If any section, provision, or part of this ordinance shall be adjudged to be invalid or unconstitutional, such adjudication shall not affect the validity of the ordinance as a whole, or any section, provision, or part thereof not adjudged invalid or unconstitutional.

Section 5. Effective Date. This ordinance shall be in effect after its final passage, approval, and posting as provided by law.

On the 7<sup>th</sup> day of April, 2026, at a regular meeting of the Tiffin City Council, Tiffin, Iowa, Councilperson \_\_\_\_ introduced Ordinance No. 2026-525, and moved that it be given its first reading. The motion was seconded by Councilperson \_\_\_\_.

Ayes:

Nays:

\_\_\_\_ members of the Council being present and having voted "Aye", Mayor Tim Kasparek declared the motion carried, and Ordinance No. 2026-525, was read the first time, discussed, and placed on record.

On the \_\_\_\_<sup>th</sup> day of \_\_\_\_, 2026, at a regular meeting of the Tiffin City Council, Tiffin, Iowa, Councilperson \_\_\_\_ introduced Ordinance No. 2026-525, and moved that it be given its second reading. The motion was seconded by Councilperson \_\_\_\_.

Ayes:

Nays:

\_\_\_\_ members of the Council being present and having voted "Aye", Mayor Tim Kasparek declared the motion carried, and Ordinance No. 2026-525, was read the second time and discussed and placed on record.

On the \_\_\_\_<sup>th</sup> day of \_\_\_\_, 2026, at a regular meeting of the Tiffin City Council, Tiffin, Iowa, Councilperson \_\_\_\_ introduced Ordinance No. 2026-525, and moved that it be given its third and last reading. The motion was seconded by Councilperson \_\_\_\_.

Ayes:

Nays:

\_\_\_\_\_ members of the Council being present and having voted "Aye", Mayor Tim Kasperek declared the motion carried, and the ordinance was passed and adopted.

Whereupon the Mayor declared that Ordinance No. 2026-525 be adopted and signified his approval of same by fixing his signature thereto. Passed by the Council on the \_\_\_\_\_th day of \_\_\_\_\_, 2026, and approved by the Mayor on the \_\_\_\_\_th day of \_\_\_\_\_, 2026.

CITY OF TIFFIN, IOWA:

By: \_\_\_\_\_  
Tim Kasperek, Mayor

ATTEST:

\_\_\_\_\_  
Abigail Hora, City Clerk

I, Abigail Hora, City Clerk of the City of Tiffin, Iowa, state that an ordinance entitled AN ORDINANCE AMENDING THE OFFICIAL ZONING MAP OF THE CITY OF TIFFIN, IOWA, TO REZONE ANDERSEN ADDITION - PART THREE, FROM R-12/OPD CONCEPT DISTRICT TO R-1D/OPD SITE AND CONCEPT DISTRICT FOR LOTUS HILL NORTH, IN THE CITY OF TIFFIN, IOWA, JOHNSON COUNTY, IOWA, AND AS LEGALLY DESCRIBED HEREIN, and known as Ordinance No. 2026-525 was duly passed by the Council on the \_\_\_\_\_th day of \_\_\_\_\_ 2026, and signed by the Mayor on the \_\_\_\_\_th day of \_\_\_\_\_ 2026, and published on the \_\_\_\_\_th day of \_\_\_\_\_ 2026, by posting copies thereof in three public places within the limits of the City of Tiffin, Iowa. That I posted copies of Ordinance No. 2026-525 in the following places:

The Depot, Tiffin, Iowa  
Tiffin City Hall, Tiffin, Iowa  
Solon State Bank, Tiffin, Iowa

\_\_\_\_\_  
Abigail Hora, City Clerk

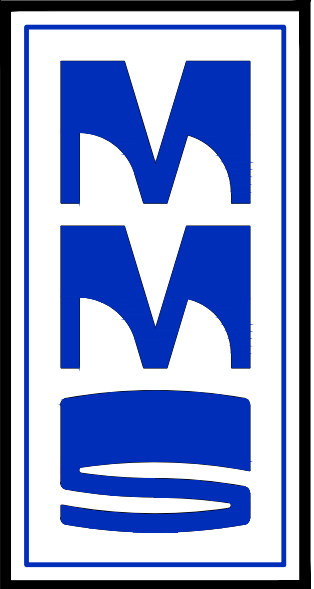

CIVIL ENGINEERS  
LAND PLANNERS  
LAND SURVEYORS  
LANDSCAPE ARCHITECTS  
ENVIRONMENTAL SPECIALISTS

1917 S. GILBERT ST.  
IOWA CITY, IOWA 52240  
(319) 351-8282  
www.mmsconsultants.net

Date Revision

REZONING EXHIBIT

TIFFIN  
JOHNSON COUNTY  
IOWA

MMS CONSULTANTS, INC.

Date: 02-12-2026  
Designed by: KJB Field Book No: 1187  
Drawn by: RLW Scale: 1"=100  
Checked by: RRR Sheet No: 1  
Project No: IOWA CITY 6385-084 of: 1

# REZONING EXHIBIT

## TIFFIN, JOHNSON COUNTY, IOWA

LEGEND AND NOTES	
▲	CONGRESSIONAL CORNER, FOUND
●	PROPERTY CORNERS, FOUND (as noted)
○	PROPERTY CORNERS SET (5/8" Iron Pin w/ yellow, plastic LS Cap embossed with "MMS")
⊙	CUT "X"
---	PROPERTY &/or BOUNDARY LINES
---	CONGRESSIONAL SECTION LINES
---	RIGHT-OF-WAY LINES
---	CENTER LINES
---	LOT LINES, INTERNAL
---	LOT LINES, PLATTED OR BY DEED
---	EASEMENT LINES, WIDTH & PURPOSE NOTED
---	EXISTING EASEMENT LINES, PURPOSE NOTED
(R)	RECORDED DIMENSIONS
(M)	MEASURED DIMENSIONS
C22-1	CURVE SEGMENT NUMBER

UNLESS NOTED OTHERWISE, ALL DIMENSIONS ARE IN FEET AND HUNDREDTHS

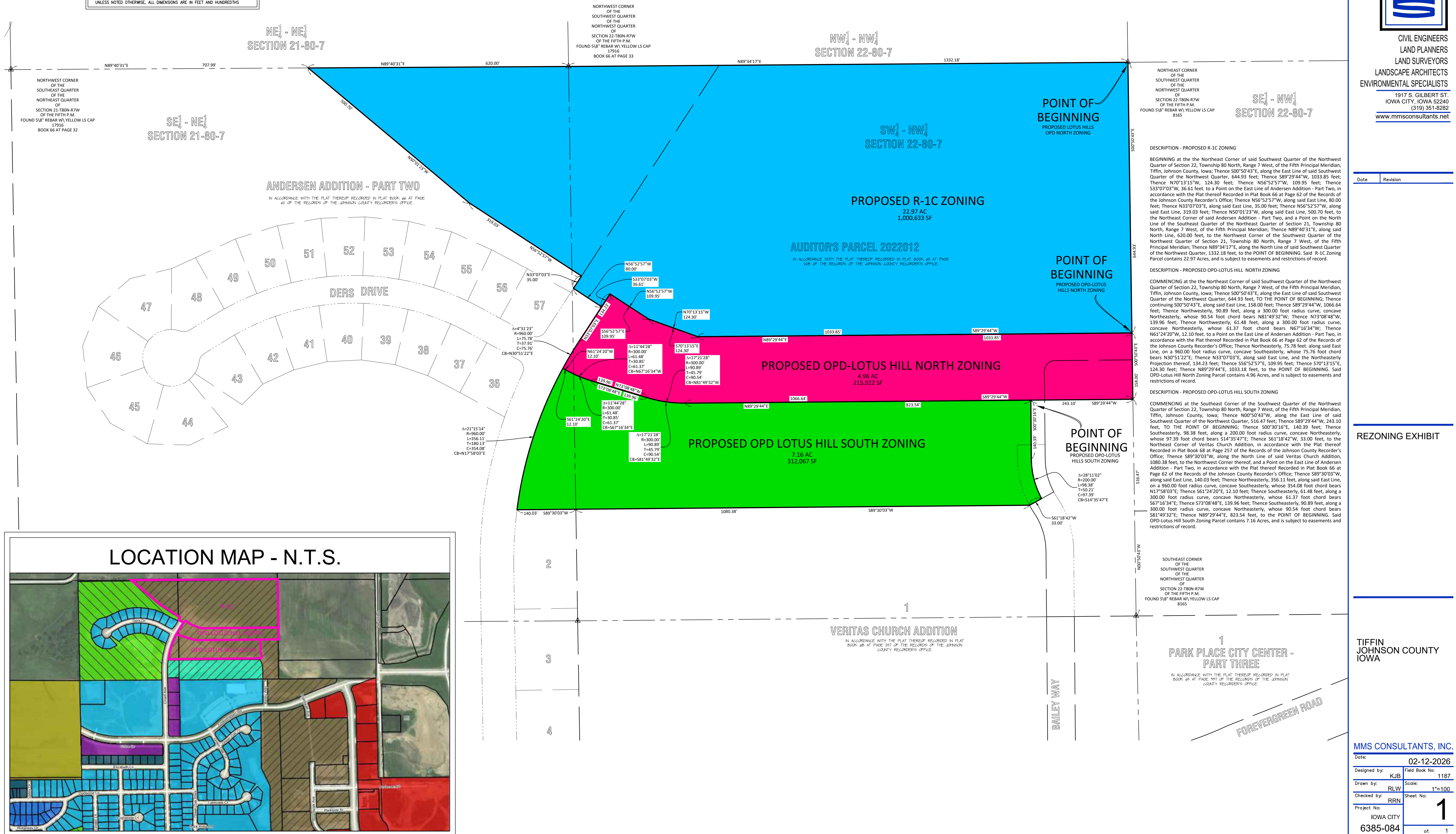
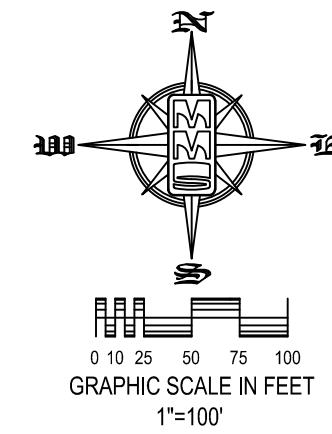

LOCATION MAP - N.T.S.

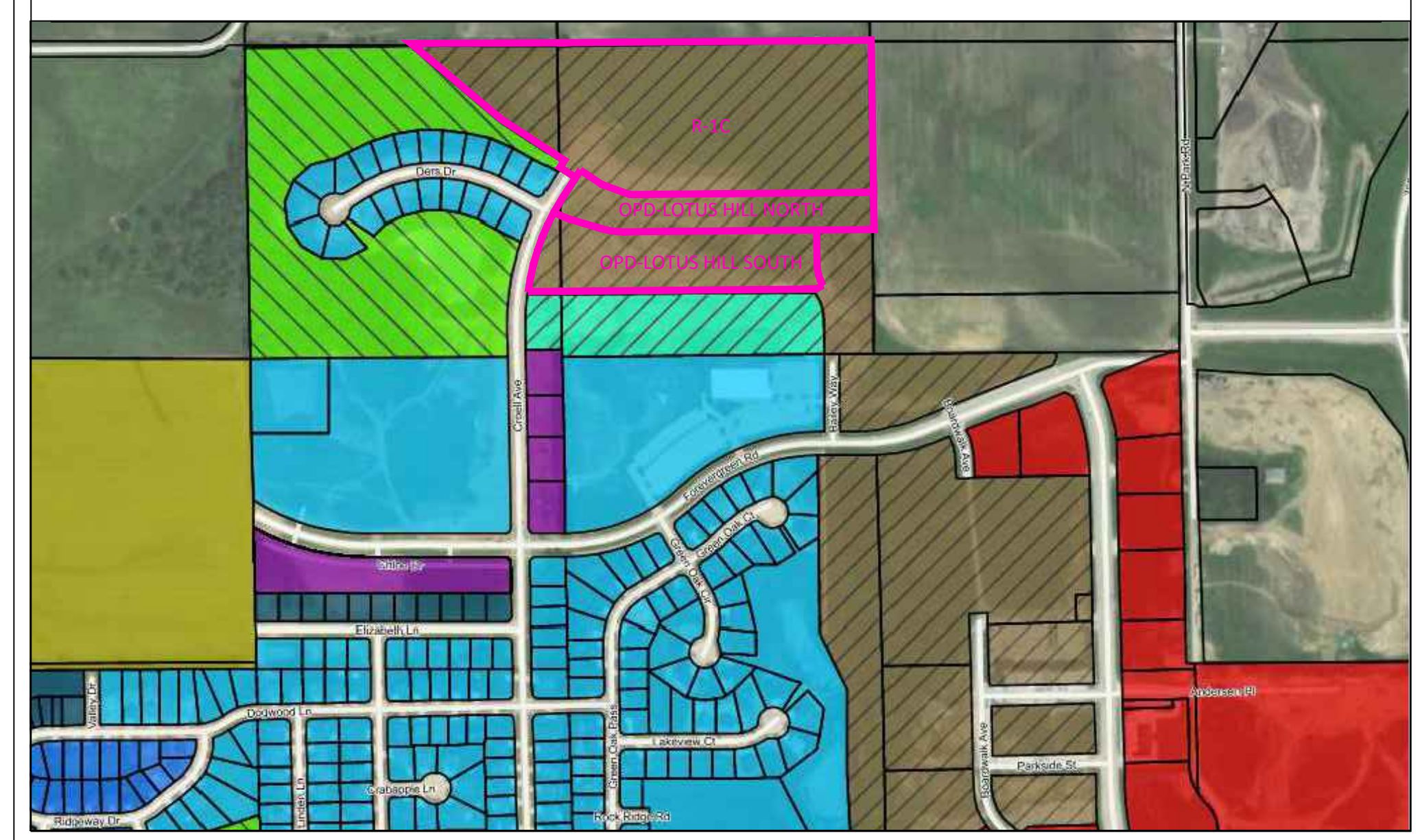

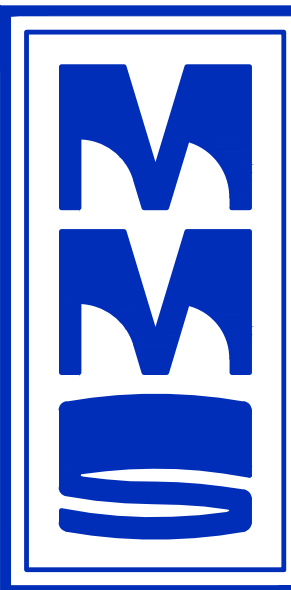

CIVIL ENGINEERS  
LAND PLANNERS  
LAND SURVEYORS  
LANDSCAPE ARCHITECTS  
ENVIRONMENTAL SPECIALISTS

1917 S. GILBERT ST.  
IOWA CITY, IOWA 52240  
(319) 351-8282  
www.mmsconsultants.net

Date	Revision

# AMENDED PRELIMINARY PLAT ANDERSEN ADDITION - PART THREE TIFFIN, IOWA

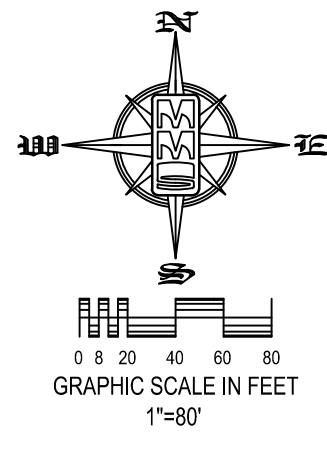
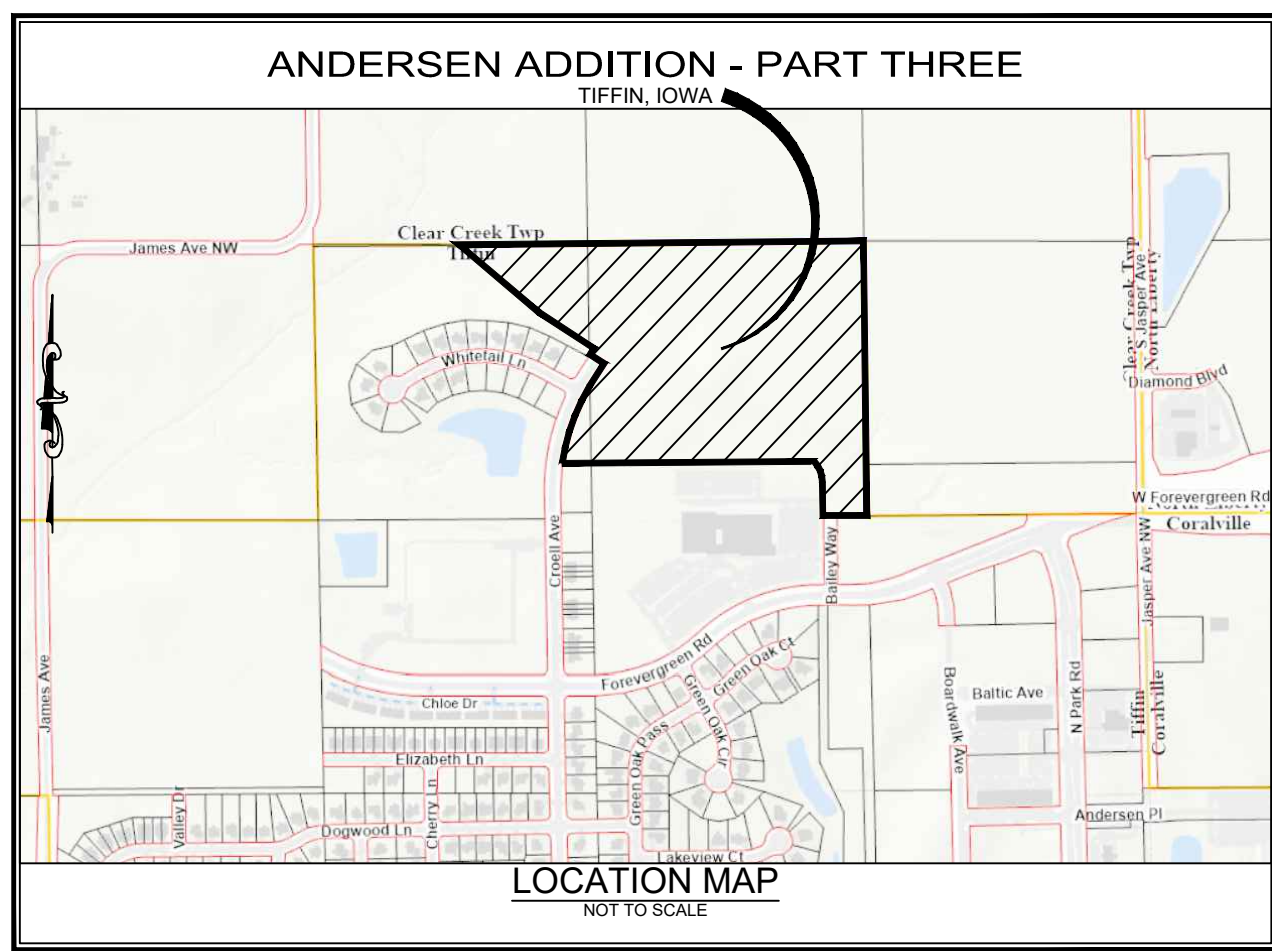

PLAT PREPARED BY:  
MMS CONSULTANTS, INC.  
1917 S. GILBERT STREET  
IOWA CITY, IA 52240

OWNER:  
HIGHTOWER DEVELOPMENT, INC  
PO BOX 5198  
CORALVILLE, IA 52241

APPLICANT:  
HIGHTOWER DEVELOPMENT, INC  
PO BOX 5198  
CORALVILLE, IA 52241

APPLICANT'S ATTORNEY:  
MATTHEW J. HEKTOEN  
SIMMONS PERRINE MOYER BERGMAN PLC  
115 3RD STREET SE, SUITE 1200  
CEDAR RAPIDS, IA 52401

- NOTES:
- ALL EASEMENTS ARE 15 FOOT UTILITY EASEMENTS UNLESS NOTED OTHERWISE. EASEMENTS SHOWN ADJACENT TO PUBLIC RIGHT-OF-WAY SHALL INCLUDE UTILITY SERVICE BY COMMERCIAL PROVIDERS.
  - THE SITE DOES NOT LIE WITHIN ANY FEMA DESIGNATED ZONES.

LOTS	ZONING	SETBACKS (VARIES PER USE)	FRONT -	REAR -	SIDE (STREET CORNER)
1-26	RIC		30 FEET	10 FEET	15 FEET
27-56	OPD		20 FEET	20 FEET	5 FEET AND 0 FEET FOR ATTACHED SINGLE FAMILY BETWEEN UNITS
57-68	OPD		20 FEET	30 FEET	15 FEET
69-70	R-12		20 FEET	30 FEET	12 FEET

PLAT/PLAN APPROVED	
by the	
City of Tiffin	
Mayor	Date

PRELIMINARY PLAT DESCRIPTION - ANDERSEN ADDITION PART THREE

BEGINNING at the Southeast Corner of the Southwest Quarter of the Northwest Quarter of Section 22, Township 80 North, Range 7 West, of the Fifth Principal Meridian, Tiffin, Johnson County, Iowa; Thence S89°30'03"W, along the North Line of Park Place City Center - Part Three, in accordance with the Plat thereof Recorded in Plat Book 65 at Page 337 of the Records of the Johnson County Recorder's Office, 147.17 feet, to the Northwest Corner thereof; Thence N00°30'16"W, along the East Right-of-Way Line of Bailey Way, 155.96 feet; Thence Northwesterly, 135.76 feet, along said East Right-of-Way Line, on a 233.00 foot radius curve, concave Southwesterly, whose 133.85 foot chord bears N17°11'48"W; Thence Northwesterly, 97.30 feet, along said East Right-of-Way Line, on a 167.00 foot radius curve, concave Northerly, whose 95.93 foot chord bears N17°11'48"W; Thence N00°30'16"W, along said East Right-of-Way Line, 24.14 feet; Thence S89°29'44"W, along the Northerly Right-of-Way Line of said Bailey Way, 66.00 feet; Thence S00°30'16"E, along the West Right-of-Way Line of said Bailey Way, 34.14 feet; Thence Southeasterly, 114.61 feet, along said West Right-of-Way Line, on a 233.00 foot radius curve, concave Northerly, whose 113.46 foot chord bears S14°35'47"E, to the Northeast Corner of said Veritas Church Addition, in accordance with the Plat thereof Recorded in Plat Book 68 at Page 257 of the Records of the Johnson County Recorder's Office; Thence S89°30'03"W, along the North Line of said Veritas Church Addition, 1089.38 feet, to the Northwest Corner thereof, and a Point on the East Line of Andersen Addition - Part Two, in accordance with the Plat thereof Recorded in Plat Book 66 at Page 62 of the Records of the Johnson County Recorder's Office; Thence S89°30'03"W, along said East Line, 140.03 feet; Thence Northwesterly, 431.90 feet, along said East Line, on a 960.00 foot radius curve, concave Southeasterly, whose 428.26 foot chord bears N20°13'44"E; Thence N33°07'03"E, along said East Line, 97.62 feet; Thence N56°52'57"W, along said East Line, 80.00 feet; Thence N33°07'03"E, along said East Line, 35.00 feet; Thence N56°52'57"W, along said East Line, 319.03 feet; Thence N50°12'33"W, along said East Line, 500.70 feet, to the Northeast Corner of said Andersen Addition - Part Two, and a Point on the North Line of the Southeast Quarter of the Northeast Quarter of Section 21, Township 80 North, Range 7 West, of the Fifth Principal Meridian; Thence N89°34'17"E, along the North Line of said Southwest Quarter of the Northwest Quarter, 1332.18 feet, to the Northeast Corner of said Southwest Quarter of the Northwest Quarter; Thence S00°50'43"E, along the East Line of said Southwest Quarter of the Northwest Quarter, 1319.40 feet, to the POINT OF BEGINNING. Said ANDERSEN ADDITION PART THREE contains 37.16 Acres, and is subject to easements and restrictions of record.

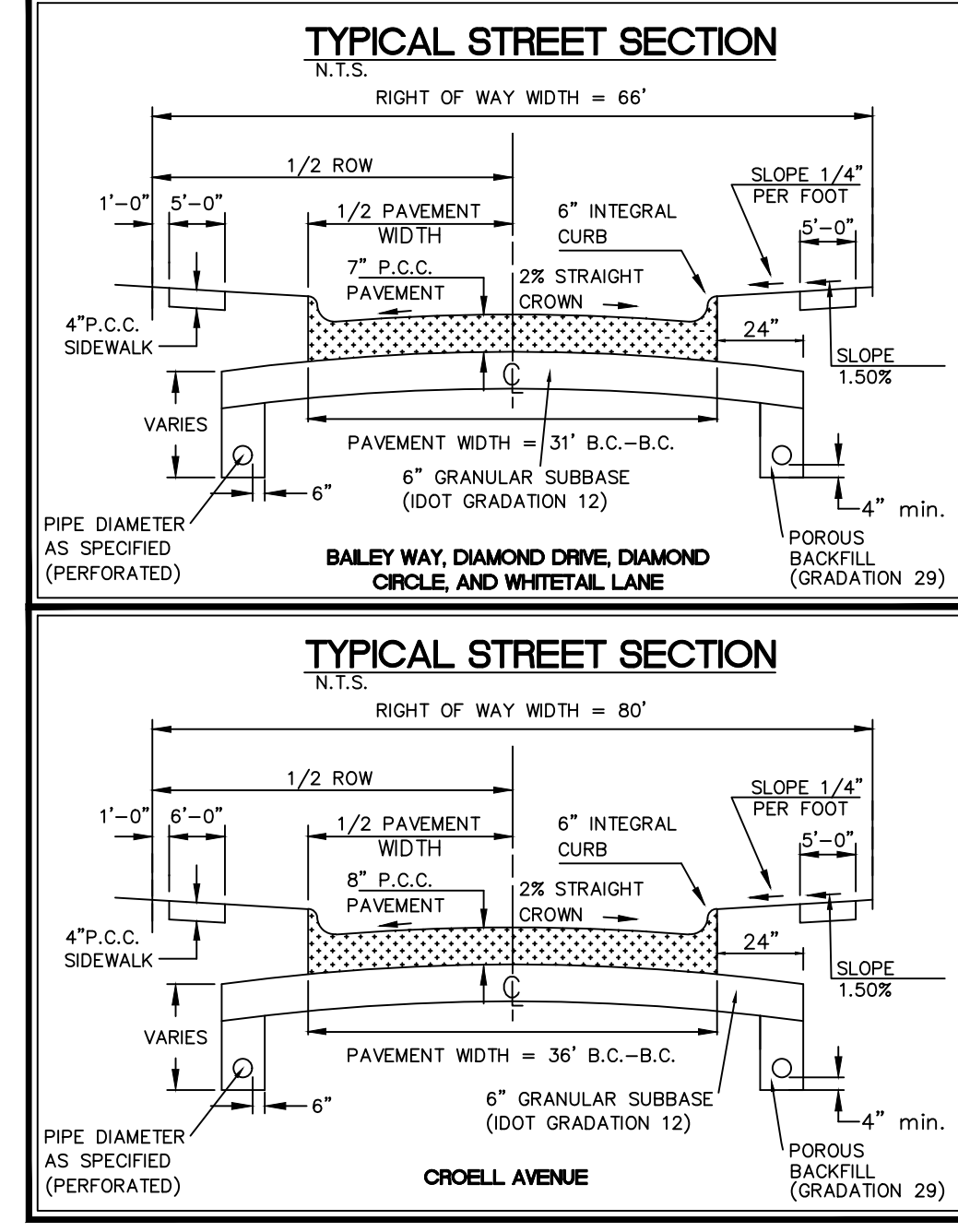
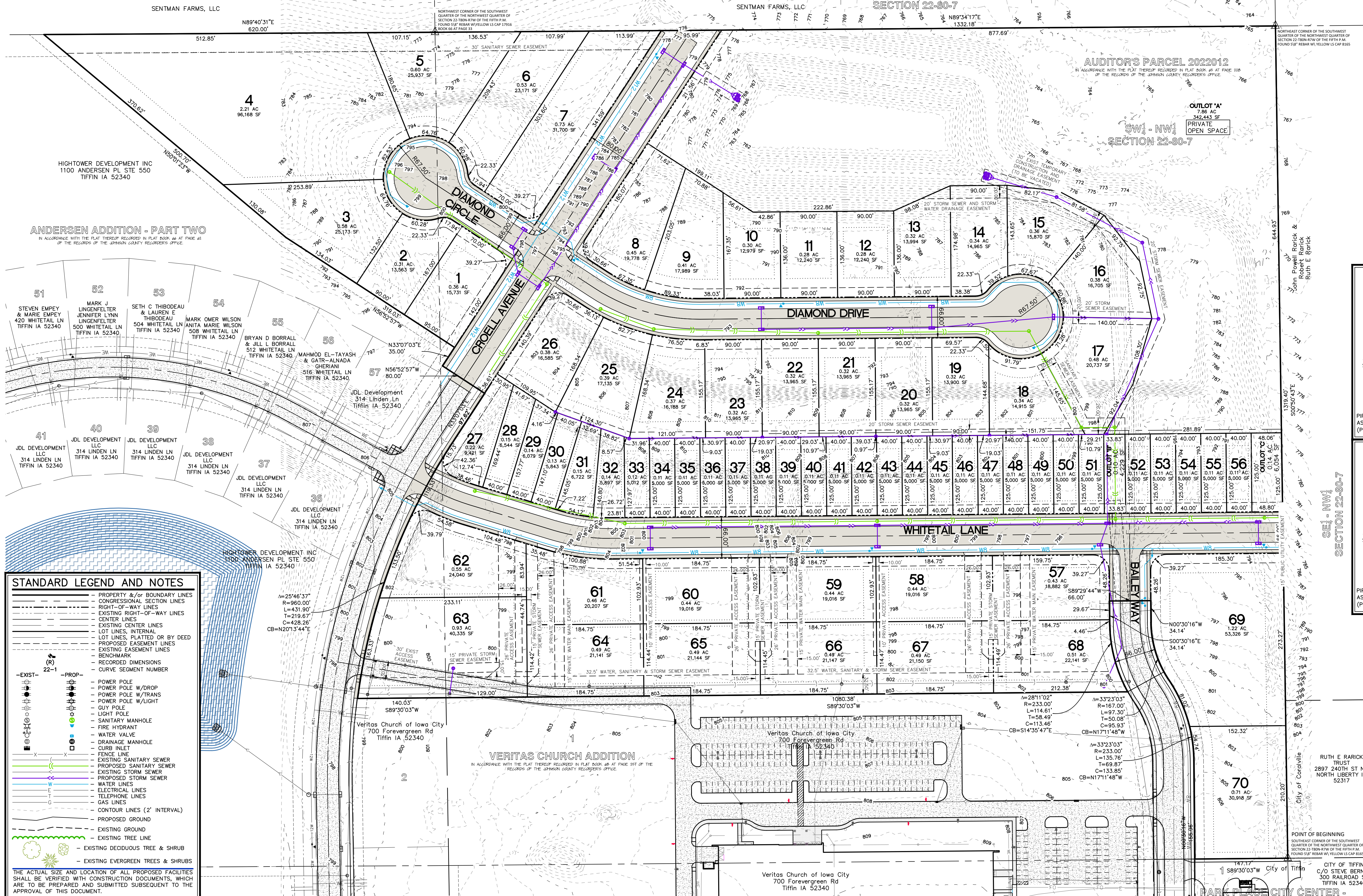

**STANDARD LEGEND AND NOTES**

- PROPERTY &/or BOUNDARY LINES
- CONGRESSIONAL SECTION LINES
- RIGHT-OF-WAY LINES
- EXISTING RIGHT-OF-WAY LINES
- CENTER LINES
- EXISTING CENTER LINES
- LOT LINES, PLATTED OR BY DEED
- PROPOSED EASEMENT LINES
- EXISTING EASEMENT LINES
- BENCHMARK
- RECORDED DIMENSIONS
- CURVE SEGMENT NUMBER

**EXIST -**

- 22-1
- POWER POLE
- POWER POLE W/DROP
- POWER POLE W/TRANS
- POWER POLE W/LIGHT
- GUY POLE
- LIGHT POLE
- SANITARY MANHOLE
- FIRE HYDRANT
- WATER VALVE
- DRAINAGE MANHOLE
- CURB INLET
- FENCE LINE
- EXISTING SANITARY SEWER
- PROPOSED SANITARY SEWER
- EXISTING STORM SEWER
- PROPOSED STORM SEWER
- WATER LINES
- ELECTRICAL LINES
- TELEPHONE LINES
- GAS LINES
- CONTOUR LINES (2' INTERVAL)
- PROPOSED GROUND
- EXISTING GROUND
- EXISTING TREE LINE
- EXISTING DECIDUOUS TREE & SHRUB
- EXISTING EVERGREEN TREES & SHRUBS

THE ACTUAL SIZE AND LOCATION OF ALL PROPOSED FACILITIES SHALL BE VERIFIED WITH CONSTRUCTION DOCUMENTS, WHICH ARE TO BE PREPARED AND SUBMITTED SUBSEQUENT TO THE APPROVAL OF THIS DOCUMENT.

AMENDED PRELIMINARY PLAT

ANDERSEN ADDITION - PART THREE  
TIFFIN JOHNSON COUNTY, IOWA

MMS CONSULTANTS, INC.

Date: 02-13-26

Designed by: KJB Field Book No:

Drawn by: TAV Scale: 1"=80'

Checked by: RAN Sheet No: 1

Project No: 6385-084 of 1

# SITE OPD EXHIBIT LOTUS HILL NORTH TIFFIN, IOWA

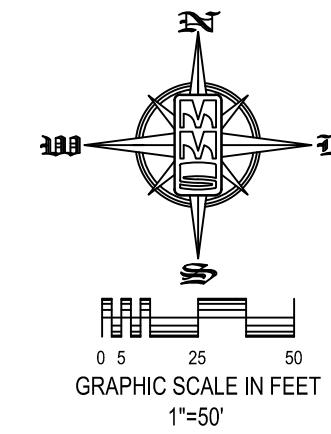

LEGAL DESCRIPTION - LOTUS HILL NORTH

LOT 27 THRU 56 AND OUTLOTS "B" AND "C", ANDERSEN ADDITION - PART THREE, TIFFIN, IOWA IN ACCORDANCE WITH THE PLAT THEREOF RECORDED IN THE RECORDS OF THE JOHNSON COUNTY RECORDER'S OFFICE, CONTAINING 3.92 ACRES, AND SUBJECT TO EASEMENTS AND RESTRICTIONS OF RECORD.

DEVELOPMENT CHARACTERISTICS  
PROPOSED ZONING: OPD-LOTUS HILL NORTH

SETBACK MINIMUMS:  
BUILDING SETBACKS: REQUIRED  
FRONT YARD: 20 FEET  
SIDE YARD: 5 FEET  
CORNER YARD: AND 0 FEET FOR ATTACHED SINGLE FAMILY BETWEEN UNITS  
REAR YARD: 15 FEET  
20 FEET

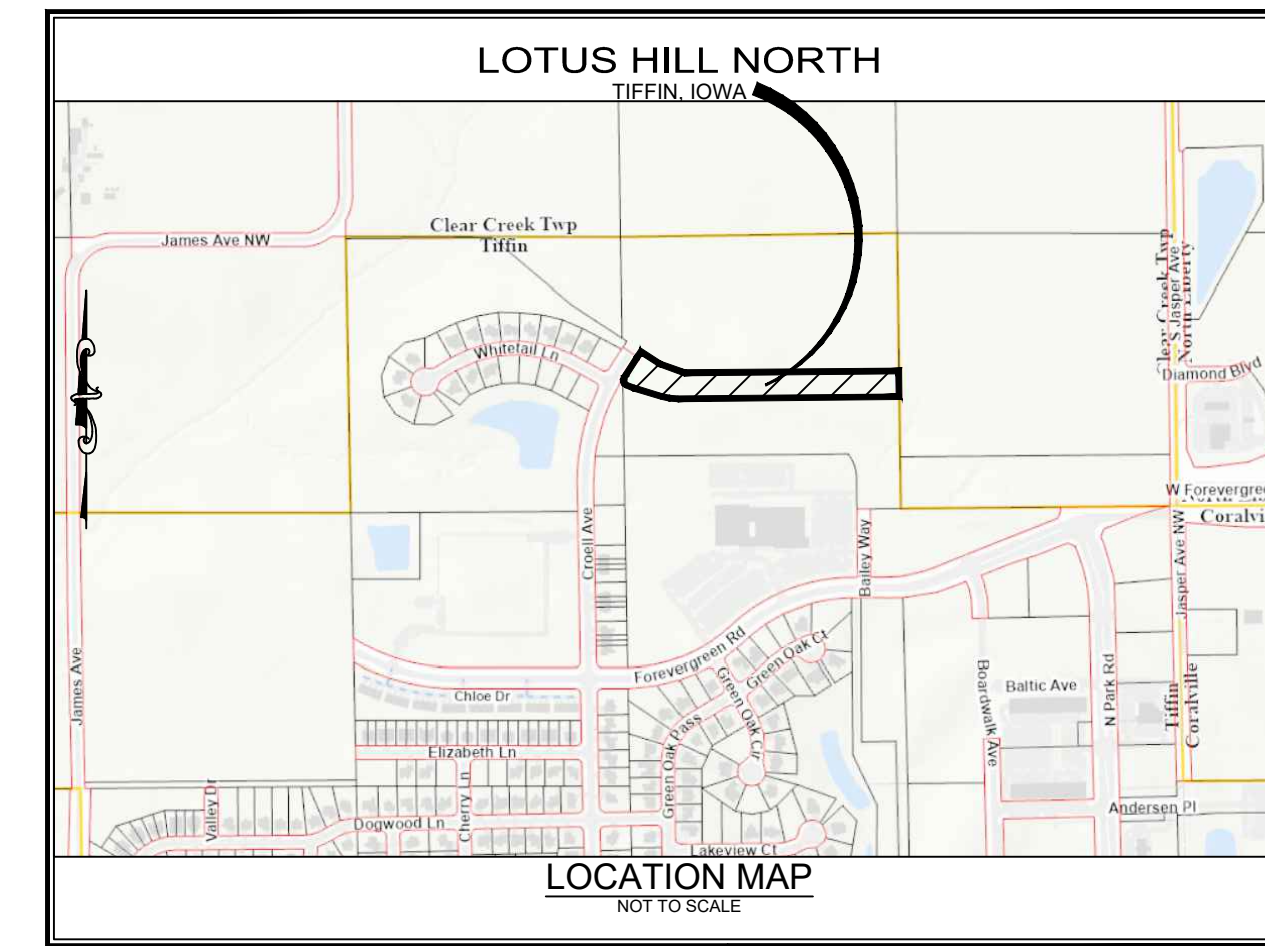

PLAT/PLAN APPROVED  
by the  
City of Tiffin

Mayer: \_\_\_\_\_ Date: \_\_\_\_\_

UTILITY EASEMENTS, AS SHOWN HEREON, MAY OR MAY NOT, INCLUDE SANITARY SEWER LINES, AND/OR STORM SEWER LINES, AND/OR WATER LINES - SEE CONSTRUCTION PLANS FOR DETAILS.

## STANDARD LEGEND AND NOTES

- PROPERTY &/or BOUNDARY LINES
  - CONGRESSIONAL SECTION LINES
  - RIGHT-OF-WAY LINES
  - EXISTING RIGHT-OF-WAY LINES
  - CENTER LINES
  - EXISTING CENTER LINES
  - LOT LINES, INTERNAL
  - LOT LINES, PLATTED OR BY DEED
  - PROPOSED EASEMENT LINES
  - EXISTING EASEMENT LINES
  - BENCHMARK
  - RECORDED DIMENSIONS
  - CURVE SEGMENT NUMBER
- EXIST - PROP
- POWER POLE W/DROP
  - POWER POLE W/TRANS
  - POWER POLE W/LIGHT
  - GUY POLE
  - LIGHT POLE
  - SANITARY MANHOLE
  - FIRE HYDRANT
  - WATER VALVE
  - DRAINAGE MANHOLE
  - CURB INLET
  - FENCE LINE
  - EXISTING SANITARY SEWER
  - PROPOSED SANITARY SEWER
  - EXISTING STORM SEWER
  - PROPOSED STORM SEWER
  - WATER LINES
  - ELECTRICAL LINES
  - TELEPHONE LINES
  - GAS LINES
  - CONTOUR LINES (1' INTERVAL)
  - PROPOSED GROUND
  - EXISTING GROUND
  - EXISTING TREE LINE
  - EXISTING DECIDUOUS TREE & SHRUB
  - EXISTING EVERGREEN TREES & SHRUBS

THE ACTUAL SIZE AND LOCATION OF ALL PROPOSED FACILITIES SHALL BE VERIFIED WITH CONSTRUCTION DOCUMENTS, WHICH ARE TO BE PREPARED AND SUBMITTED SUBSEQUENT TO THE APPROVAL OF THIS DOCUMENT.



CIVIL ENGINEERS  
LAND PLANNERS  
LAND SURVEYORS  
LANDSCAPE ARCHITECTS  
ENVIRONMENTAL SPECIALISTS

1917 S. GILBERT ST.  
IOWA CITY, IOWA 52240  
(319) 351-8282  
www.mmsconsultants.net

Date: \_\_\_\_\_ Revision: \_\_\_\_\_



## SITE OPD EXHIBIT LOTUS HILL NORTH

ANDERSEN  
ADDITION -  
PART THREE  
TIFFIN  
JOHNSON COUNTY,  
IOWA

MMS CONSULTANTS, INC.  
Date: 02-16-26  
Designed by: KJB Field Book No:  
Drawn by: TAV Scale: 1"=50'  
Checked by: RAN Sheet No: 1  
Project No: 6385-084 of. 1

SINGLE-STORY DUPLEX A



SINGLE-STORY DUPLEX B



TWO-STORY DUPLEX C



TWO-STORY DUPLEX D



SINGLE-FAMILY A



SINGLE-FAMILY B



# LOTUS HILL NORTH

# SITE OPD EXHIBIT LOTUS HILL SOUTH TIFFIN, IOWA

## LANDSCAPE REQUIREMENTS

- 1 STREET TREE FOR EVERY 60 LF OF FRONTAGE.  
1,634 / 60 = 27 REQUIRED  
27 PROVIDED
- 1 TREE FOR EVERY 550 SF OF BUILDING FOOTPRINT.  
73,440 / 550 = 134 REQUIRED  
70 PROVIDED

LEGAL DESCRIPTION - LOTUS HILL SOUTH  
LOT 57 THRU 68, ANDERSEN ADDITION - PART THREE, TIFFIN, IOWA IN ACCORDANCE  
WITH THE PLAT THEREOF RECORDED IN THE RECORDS OF THE JOHNSON COUNTY  
RECORDER'S OFFICE, CONTAINING 8.14 ACRES, AND SUBJECT TO EASEMENTS AND  
RESTRICTIONS OF RECORD.

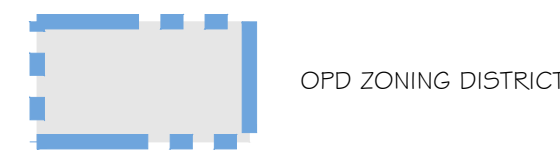

## PLANT SCHEDULE

- SHADE TREE 1.5" DIA. 19
- STREET TREE 1.5" DIA. 27
- ORNAMENTAL TREE 1.5" DIA. 24
- EVERGREEN SHRUB 1.5" HT. 121

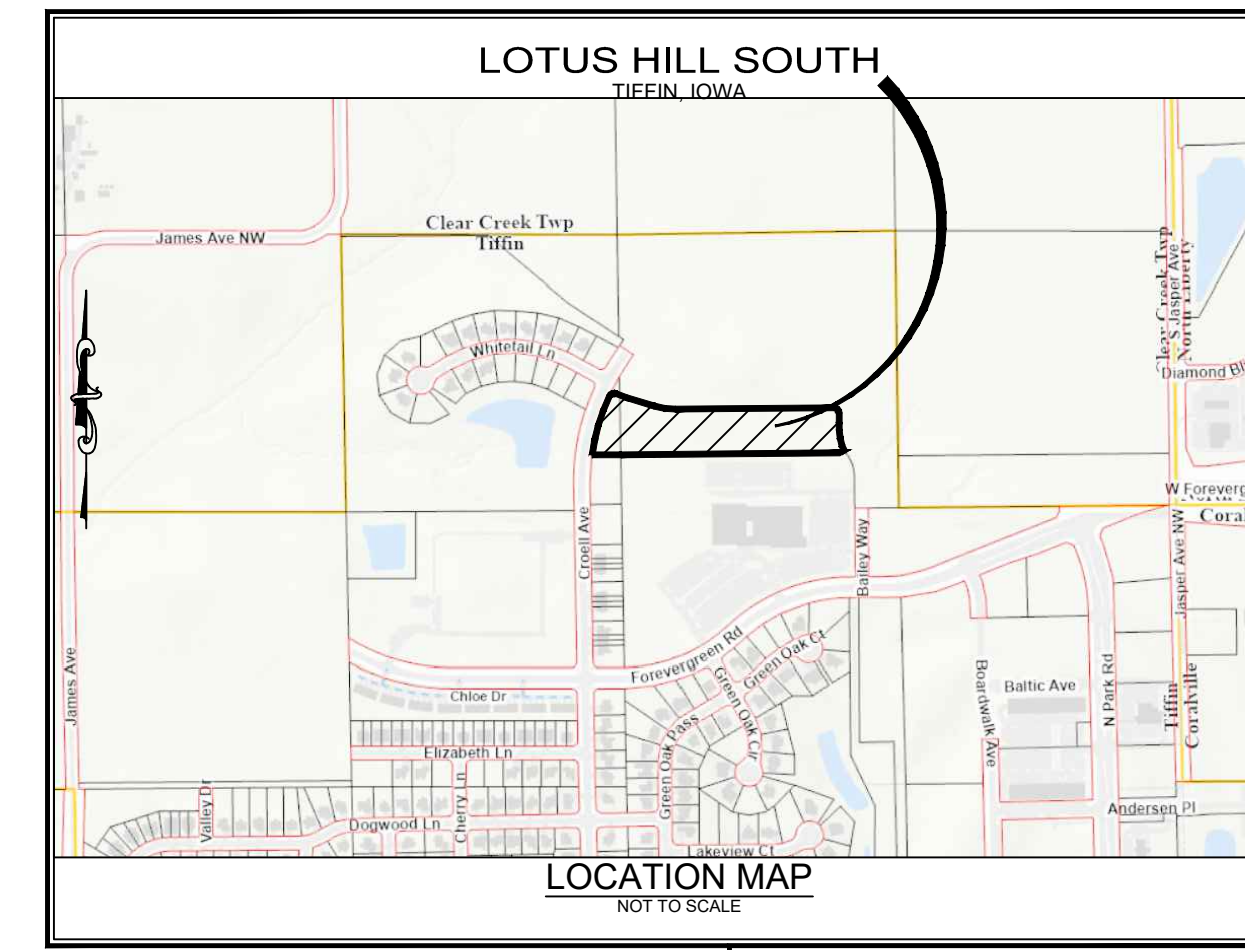
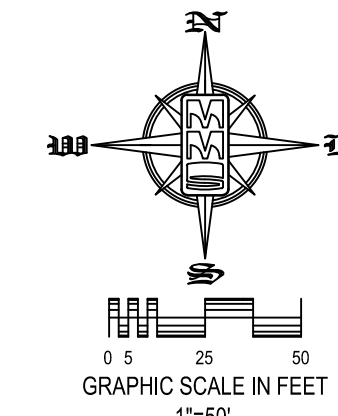

## STANDARD LEGEND AND NOTES

- PROPERTY &/or BOUNDARY LINES
- CONGRESSIONAL SECTION LINES
- RIGHT-OF-WAY LINES
- EXISTING RIGHT-OF-WAY LINES
- CENTER LINES
- EXISTING CENTER LINES
- LOT LINES, INTERNAL
- LOT LINES, PLATTED OR BY DEED
- PROPOSED EASEMENT LINES
- EXISTING EASEMENT LINES
- BENCHMARK
- RECORDED DIMENSIONS
- CURVE SEGMENT NUMBER
- EXISTING POWER POLE W/DROP
- PROPOSED POWER POLE W/DROP
- EXISTING POWER POLE W/TRANS
- PROPOSED POWER POLE W/TRANS
- EXISTING GUY POLE
- PROPOSED GUY POLE
- EXISTING LIGHT POLE
- PROPOSED LIGHT POLE
- EXISTING SANITARY MANHOLE
- PROPOSED SANITARY MANHOLE
- EXISTING FIRE HYDRANT
- PROPOSED FIRE HYDRANT
- EXISTING WATER VALVE
- PROPOSED WATER VALVE
- EXISTING DRAINAGE MANHOLE
- PROPOSED DRAINAGE MANHOLE
- EXISTING CURB INLET
- PROPOSED CURB INLET
- EXISTING FENCE LINE
- PROPOSED FENCE LINE
- EXISTING EXISTING SANITARY SEWER
- PROPOSED EXISTING SANITARY SEWER
- EXISTING EXISTING STORM SEWER
- PROPOSED EXISTING STORM SEWER
- EXISTING WATER LINES
- PROPOSED WATER LINES
- EXISTING ELECTRICAL LINES
- PROPOSED ELECTRICAL LINES
- EXISTING TELEPHONE LINES
- PROPOSED TELEPHONE LINES
- EXISTING GAS LINES
- PROPOSED GAS LINES
- EXISTING CONTOUR LINES (1' INTERVAL)
- PROPOSED CONTOUR LINES
- EXISTING EXISTING GROUND
- PROPOSED EXISTING GROUND
- EXISTING EXISTING TREE LINE
- PROPOSED EXISTING TREE LINE
- EXISTING EXISTING DECIDUOUS TREE & SHRUB
- PROPOSED EXISTING DECIDUOUS TREE & SHRUB
- EXISTING EXISTING EVERGREEN TREES & SHRUBS
- PROPOSED EXISTING EVERGREEN TREES & SHRUBS

PLAT/PLAN APPROVED  
by the  
City of Tiffin

## DEVELOPMENT CHARACTERISTICS

- PROPOSED ZONING: OPD-LOTUS HILL SOUTH
- SETBACK MINIMUMS:  
BUILDING SETBACKS: 20 FEET  
FRONT YARD: 20 FEET  
SIDE YARD: 05 FEET  
CORNER YARD: 15 FEET  
REAR YARD: 20 FEET
- PARKING REQUIREMENTS:  
MULTI-FAMILY UNITS: 1.4 SPACES \* 144 UNITS = 202 SPACES  
SPACES REQUIRED: 202 SPACES  
SPACES PROVIDED: 214 TOTAL

THE ACTUAL SIZE AND LOCATION OF ALL PROPOSED FACILITIES SHALL BE VERIFIED WITH CONSTRUCTION DOCUMENTS, WHICH ARE TO BE PREPARED AND SUBMITTED SUBSEQUENT TO THE APPROVAL OF THIS DOCUMENT.

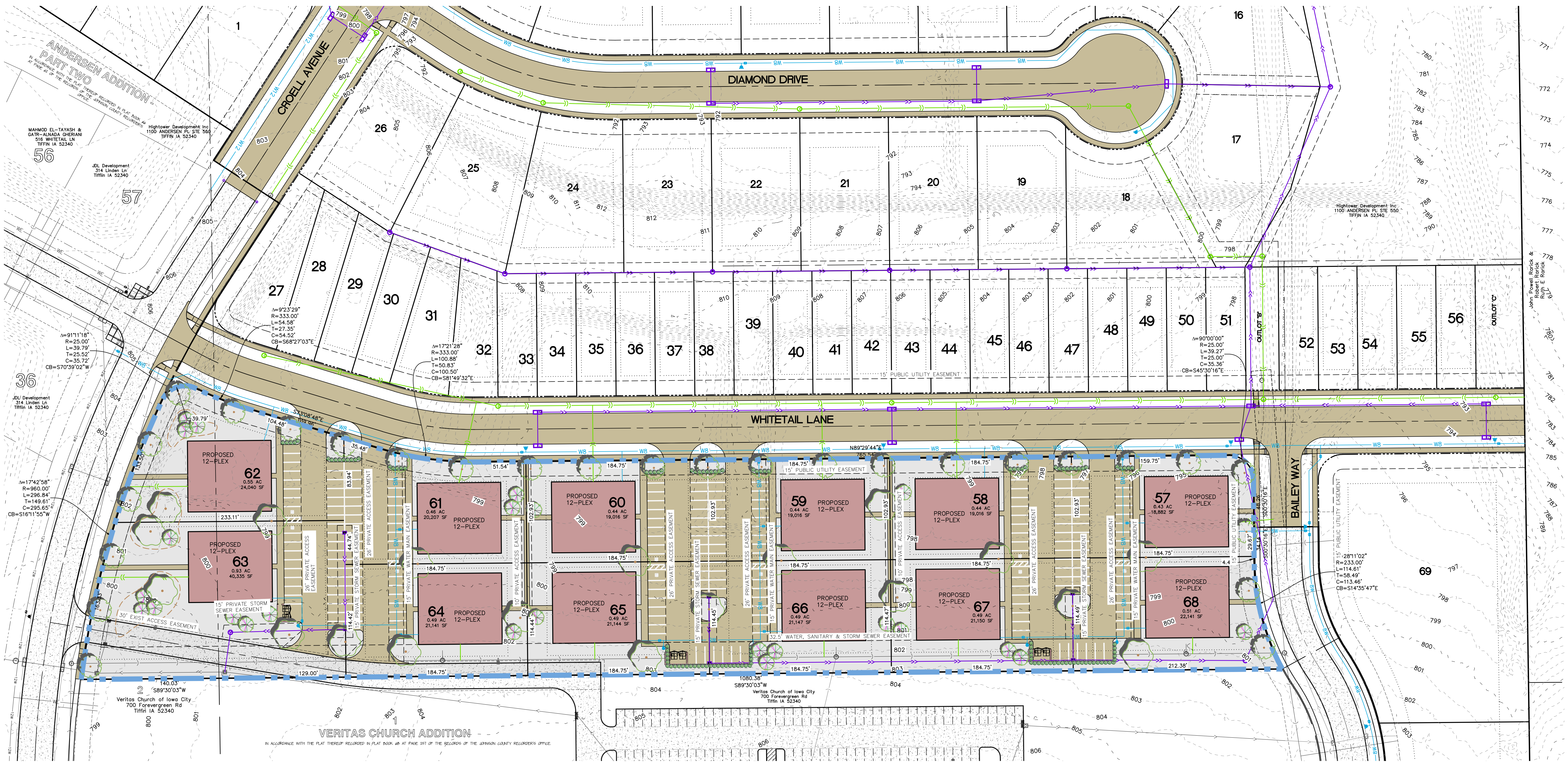

CIVIL ENGINEERS  
LAND PLANNERS  
LAND SURVEYORS  
LANDSCAPE ARCHITECTS  
ENVIRONMENTAL SPECIALISTS

1917 S. GILBERT ST.  
IOWA CITY, IOWA 52240  
(319) 351-8282  
www.mmsconsultants.net

Date	Revision

## SITE OPD EXHIBIT LOTUS HILL SOUTH

## ANDERSEN ADDITION - PART THREE TIFFIN JOHNSON COUNTY, IOWA

MMS CONSULTANTS, INC.

Date:	02-16-26
Designed by:	KJB
Drawn by:	TAV
Checked by:	RAN
Project No:	6385-084
Field Book No:	FIELDBOOK
Scale:	1"=50'
Sheet No:	1
of:	1

OPTION ONE



OPTION TWO



OPTION THREE

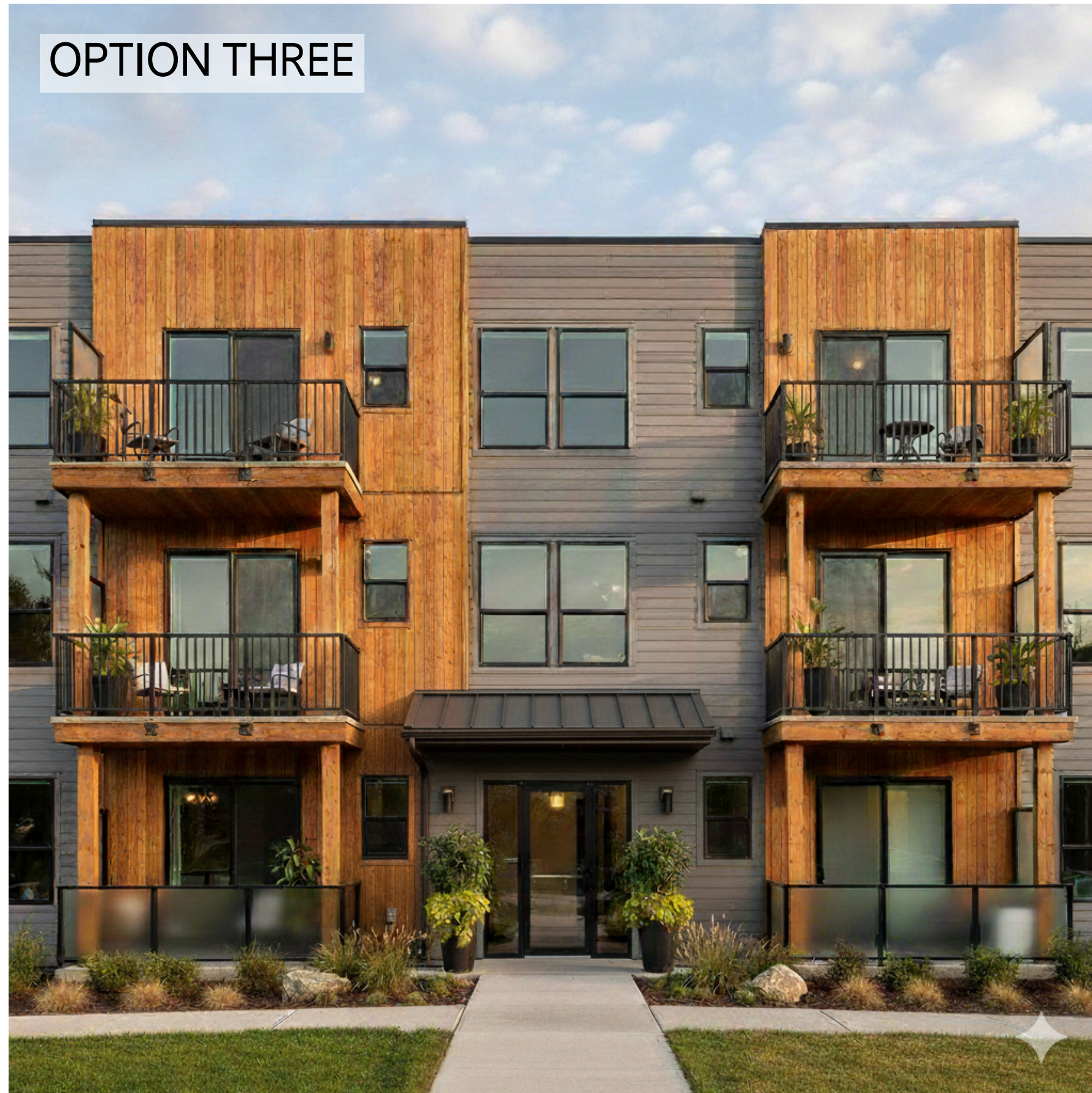

OPTION FOUR



**LOTUS  
HILL  
SOUTH**